

www.tempLED.de

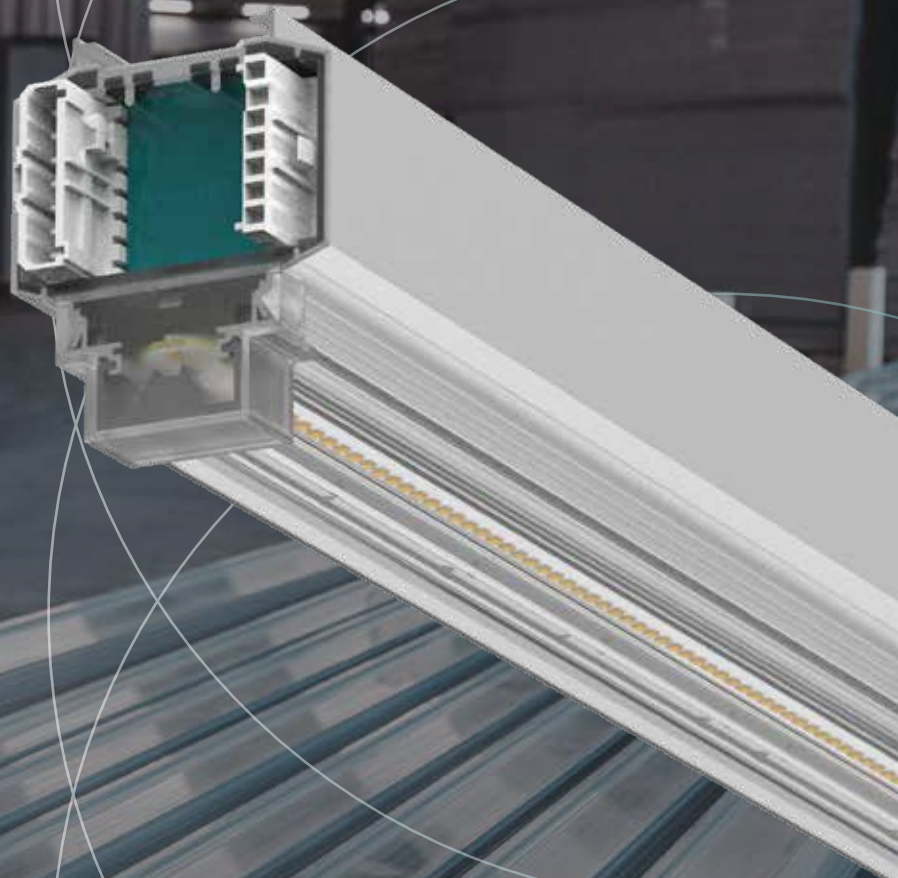

tempLED



LINE LIGHTING SYSTEM

tempLED RayLine Max V3

15 | 25 | 40 | 70 | 100

HALL LIGHTS 

HIGH TEMPERATURES 

Our customer
Dinkhauser

tempLED

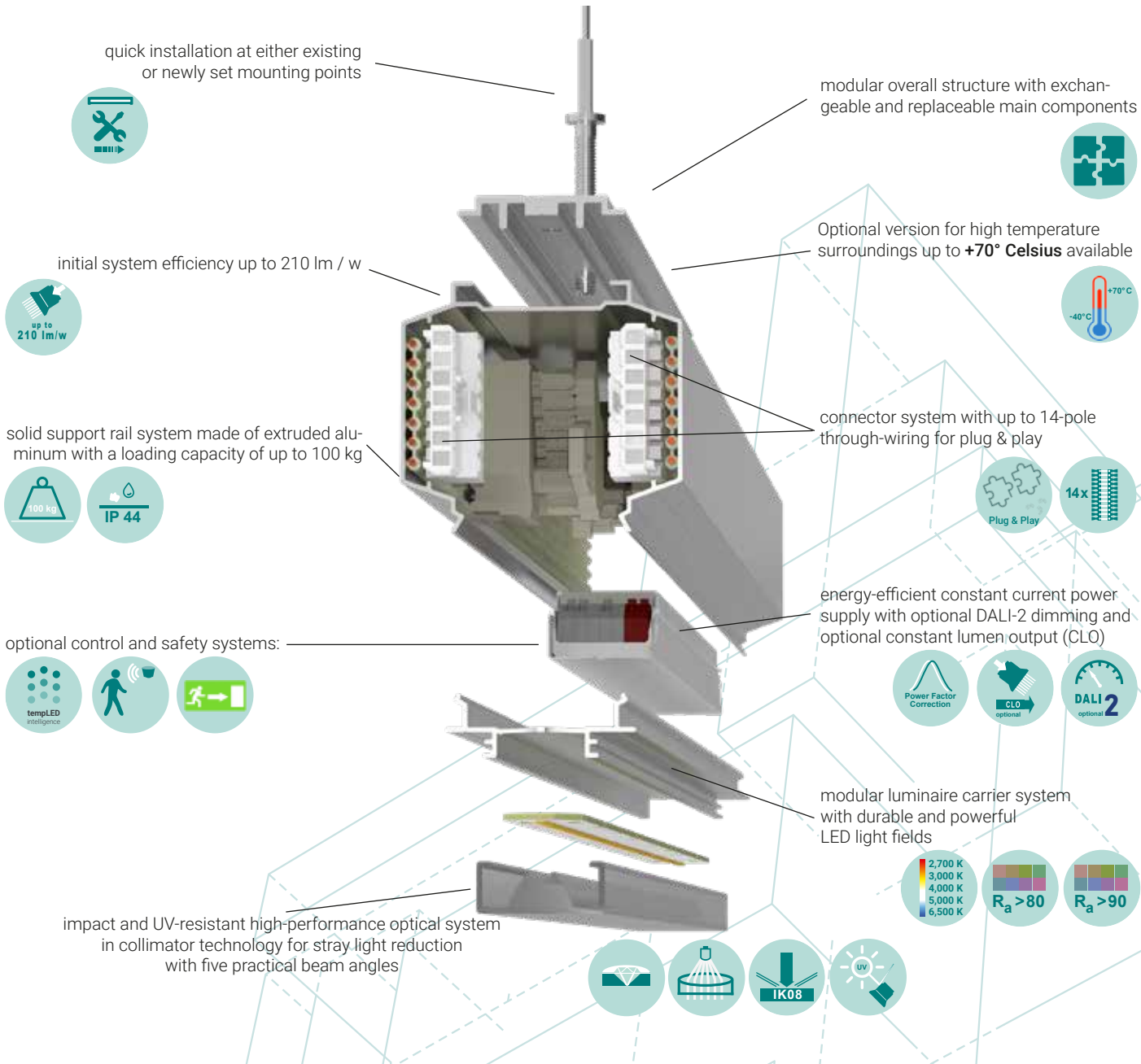

Light distribution curves tempLED RayLine Max V3

15 | 25 | 40 | 70 | 100



tempLED

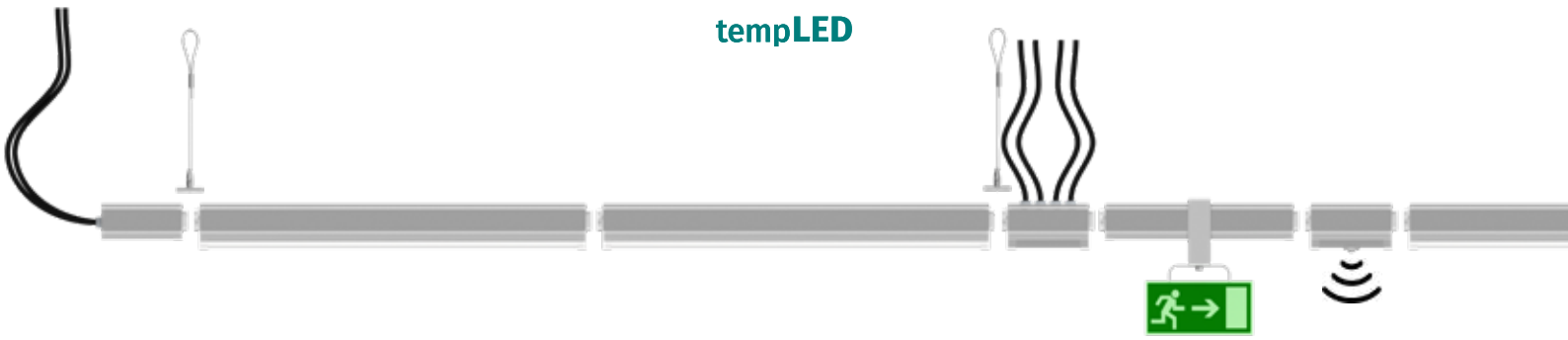

tempLED RayLine Max V3

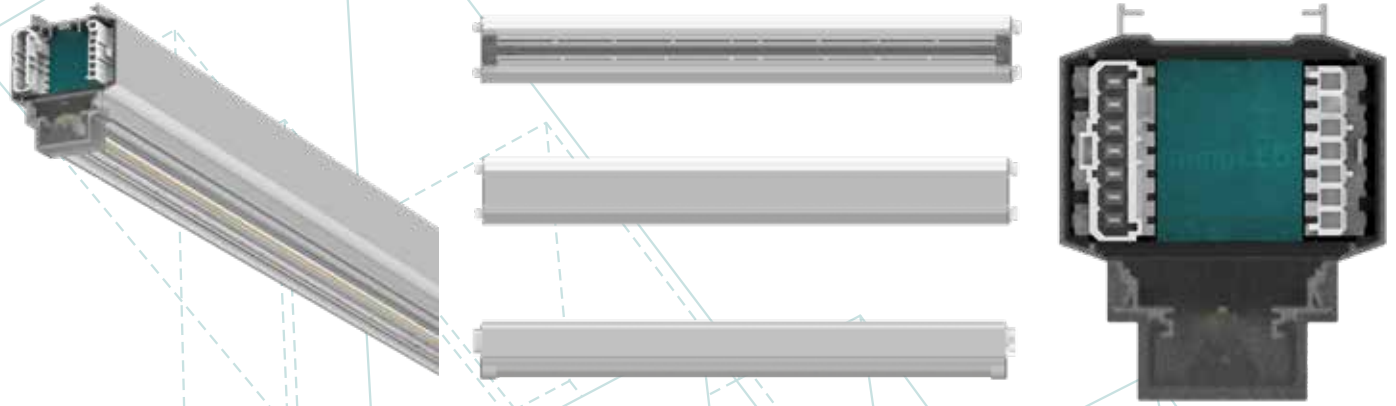

Dimensions tempLED RayLine Max V3

1,680 mm | 3,360 mm | 5,040 mm

1,680 mm



3,360 mm



5,040 mm



70.8 mm



84.2 mm

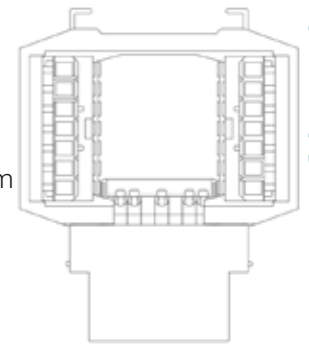

Mounting options tempLED RayLine Max V3

ceiling mounting
adapter

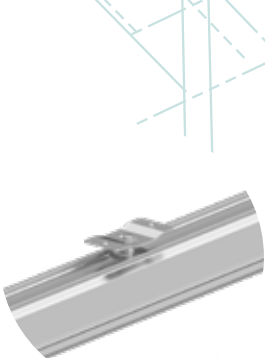

height-adjustable
rope suspension
(0.10 - 4.90 m)
combined with
loop

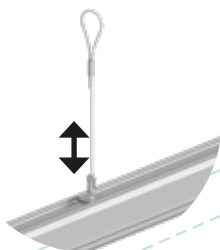

height-adjustable
rope suspension
(0.10 - 4.90 m)
combined with
carabiner hook

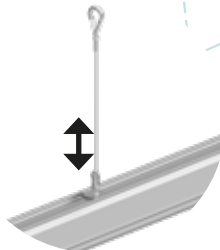

height-adjustable
rope suspension
(0.10 - 4.90 m)
combined with
trapezoidal sheet hook

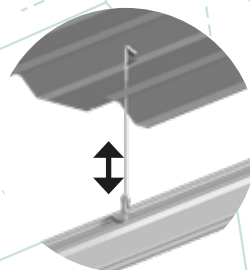

height-adjustable
rope suspension
(0.10 - 4.90 m)
combined with
concrete anchor

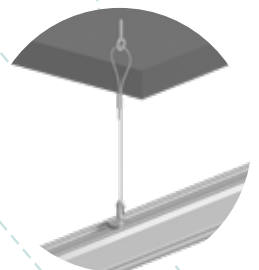

General technical data

according to IEC, identical for all types of luminaires



Lighting properties:

initial luminous flux:	up to 18,500 lumens
luminous flux tolerance:	± 10 percent
initial system efficiency:	up to 210 lumens / watt
initial, most similar color temperature:	2,700 3,000 4,000 5,000 6,500 kelvins ¹
initial color rendering index (CRI):	Ra > 80 Ra > 90
initial color consistency:	< 3 SDCM
available symmetric beam angles:	BATWING INTENSE OPAL
available asymmetrical beam angles:	ASY (left- and right-sided) DAS
photobiological safety:	IEC/TR 62778: 1
compact flicker degree (CFD):	on request
stray light reduction:	yes, with collimator technology

Electrotechnical properties:

power supply AC:	198 to 240 volts
supply frequency:	50 / 60 hertz
power supply DC:	176 to 250 volts
system performance:	15 to 100 watts
system performance tolerance:	± 10 percent
power factor:	> 0.95
overvoltage protection:	yes
overheating protection:	yes
temperature monitoring:	yes
total harmonic distortion (THD):	< 10 percent
temperature classification (ATEX):	T6
Tc - temperature:	+75 degrees Celsius
suitable for emergency light installations:	yes, in accordance with EN 60598-2-22 and IEC 61347-2-13, Annex J through DC detection (0 Hz, pulsating DC), can be switched on/off; on request: dimming to 15 percent of the nominal power in DC mode

Energy characteristics:

Valid for all tempLED RayLine Max V3 with up to 192 lumens per watt:	This product contains a light source of energy efficiency class B.
Valid for all tempLED RayLine Max V3 from 193 lumens per watt:	This product contains a light source of energy efficiency class A.

Mounting options:

mounting options:	ceiling mounting height-adjustable pendant mounting with cable suspension (0.10 to 4.90 m)
-------------------	---

¹ additional color temperatures on request.

Control and safety properties:

dimming:	DALI-2 optional
minimum dimming level:	10 percent
constant lumen output (CLO):	optional
control via the Casambi network:	optional (types with DALI dimming only) ¹
control via the ENLIGHTED network:	optional (types with DALI dimming only) ²
emergency power module:	optional ¹
human centric lighting:	on request
daylight control system:	optional via Casambi ¹ network or SensorSystem ³ (types with DALI dimming only)
occupancy control:	optional via ENLIGHTED ² or SensorSystem ³ (types with DALI dimming only)

Housing properties:

standard ambient temperature:	-40 to +50 degrees Celsius
optional ambient temperature:	-40 to +70 degrees Celsius
standard ingress protection:	IP 44
optional ingress protection:	IP 55
impact resistance level:	IK08
electrical protection class:	I
limited surface temperatur (D):	yes
housing and heat sink material(s):	extruded aluminium profile
material of optical system:	impact- and UV-resistant PMMA
material of diffuser:	impact resistant polycarbonate
luminaire housing color:	aluminum natural ⁴
surface finish:	bare ⁵
supply cable inlet:	cable glands
standard number of poles with through-wiring:	10
optional number of poles with through-wiring:	12 14
maximum tensile load on the cover profile:	1.50 kilograms

Additional information:

certificates:	ENEC in preparation
conformities:	CE RoHS DIN 10500 (HACCP IFS) ⁵
lifespan (L70B10C1):	approx. 100,000 hours
lifespan (L90B10C1):	approx. 50,000 hours
guarantee:	5 years ⁶
spare part guarantee:	10 years
delievery includes:	prefabricated luminaire

¹ can only be used at ambient temperatures of max. +50 degrees Celsius. ² can only be used at ambient temperatures from 0 to +50 degrees Celsius.

³ can only be used at ambient temperatures from -20 to +45 degrees Celsius.

⁴ optional luminaire housing colors and finishes: Paintings according to RAL colour chart, powder coatings according to RAL colour chart or synthetic resin coating.

⁵ DIN 10500 only valid for luminaires with opal polycarbonate diffuser.

⁶ according to the warranty conditions of tempLED GmbH, excluding accessories.

Logistic information:

maximum weight per mounting rail unit with 1,68 meter length:	approx. 4,200 g
maximum weight per mounting rail unit with 3,36 meter length:	approx. 8,000 g
maximum weight per mounting rail unit with 5,04 meter length:	approx. 12,000 g
amount of line meter per wooden box:	105,84
dimensions per wooden box L x W x H:	5,131 x 784 x 425 mm
net weight per wooden box:	20,000 g



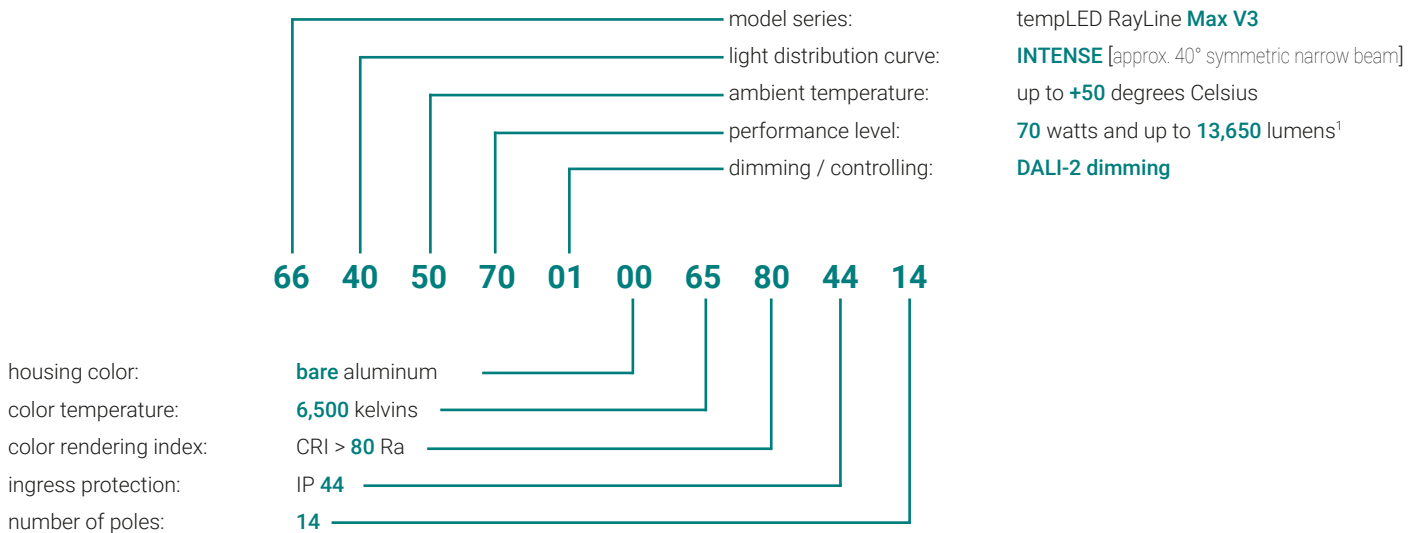







tempLED RayLine Max V3 - this is how you order your line light: sample article number







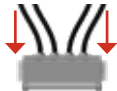
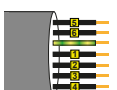



tempLED RayLine Max V3 - all variants and options at a glance: article number matrix

model series:	66									tempLED RayLine Max V3
light distribution curve:		20								ASY [left-sided approx. 20° asymmetric narrow beam]
		21								ASY [right-sided approx. 20° asymmetric narrow beam]
		90								BATWING [approx. 90° symmetric wide beam]
		22								DASY [two-sided approx. 2x20° asymmetric narrow beam]
		40								INTENSE [approx. 40° symmetric narrow beam]
		12								OPAL [approx. 120° symmetric diffuse light distribution]
ambient temperature:			50							-40 to +50 degrees Celsius
			70							-40 to +70 degrees Celsius
performance level:				15						15 watts / up to 3,150 lumens ¹
				25						25 watts / up to 5,000 lumens ¹
				40						40 watts / up to 8,000 lumens ¹
				70						70 watts / up to 13,650 lumens ¹
				99						100 watts / up to 18,500 lumens ¹
controlling / dimming:					00					on / off
					01					DALI-2 dimming
					11					constant lumen output (CLO)
housing color:						00				aluminium bare
color temperature:							27			2,700 kelvins
							30			3,000 kelvins
							40			4,000 kelvins (standard color temperature)
							50			5,000 kelvins
							65			6,500 kelvins
color rendering index:								80		CRI > 80 Ra
								90		CRI > 90 Ra
ingress protection:									44	IP 44
									55	IP 55
number of poles:									10	10-pole with through-wiring
									12	12-pole with through-wiring
									14	14-pole with through-wiring

¹ The specified maximum initial luminous flux depends on the selected colour temperature, the selected colour rendering index and the selected optical system.

tempLED	System components catalogue RayLine Max V3	art.-no.	GTIN / EAN
	rail connector for connecting two mounting rails including a fastening point for steel cable suspension and two rotary knob screws, length: 280 mm, material: aluminium, finish: aluminum bare	065500	4260745235396
	mounting adapter for flexible and freely selectable assembly of new or already installed rope suspensions on the RayLine V3 mounting rails, material: steel, finish: hot-dip galvanized	065501	4260745235402
	ceiling mounting adapter for direct mounting of RayLine V3 mounting rails on ceilings, flexible alignment, distance to surface: approx. 20 mm, material: steel, finish: hot-dip galvanized, delivered as a set with mounting adapter 065501	065502	4260745235419
	screw hook, size M6 for direct mounting of RayLine V3 mounting rails on newly installed or already existing chain suspensions, max. opening: 15 mm, with safety lock, material: steel, finish: nickel-plated, for use with 065500 or 065501	090129	4260745233767
	rope suspension with loop material: steel, finish: galvanized, for use with 065500 or 065501 rope length: 1.00 m , adjustable suspension length: from 0.10 to 0.90 m rope length: 3.00 m , adjustable suspension length: from 0.10 to 2.90 m rope length: 5.00 m , adjustable suspension length: from 0.10 to 4.90 m	065520 065521 065522	4260745235631 4260745235648 4260745235655
	rope suspension with carabiner hook material: steel, finish: galvanized, for use with 065500 or 065501 rope length: 1.00 m , adjustable suspension length: from 0.10 to 0.90 m rope length: 3.00 m , adjustable suspension length: from 0.10 to 2.90 m rope length: 5.00 m , adjustable suspension length: from 0.10 to 4.90 m	065523 065524 065525	4260745235662 4260745235679 4260745235686
	rope suspension with trapezoidal sheet hook material: steel, finish: galvanized, for use with 065500 or 065501 rope length: 1.00 m , adjustable suspension length: from 0.10 to 0.90 m rope length: 3.00 m , adjustable suspension length: from 0.10 to 2.90 m rope length: 5.00 m , adjustable suspension length: from 0.10 to 4.90 m	065526 065527 065528	4260745235693 4260745235709 4260745235716
	rope suspension with concrete anchor material: steel, finish: galvanized, for use with 065500 or 065501 rope length: 1.00 m , adjustable suspension length: from 0.10 to 0.90 m rope length: 3.00 m , adjustable suspension length: from 0.10 to 2.90 m rope length: 5.00 m , adjustable suspension length: from 0.10 to 4.90 m	065529 065530 065531	4260745235723 4260745235730 4260745235747
	start or end feed as a kit, 14-pole set for self-assembly, for feeding in at the beginning or the end of the RayLine Max V3 line lighting system, two cable glands integrated at the front in size M32 without connection cable integrated in a mounting rail, length: 140 mm, material: aluminium, finish: aluminum bare start feed end feed	066501 066502	4260745237741 4260745237864
	center feed as a kit, 2 x 14-pole set for self-assembly, for feeding in in the center of the RayLine Max V3 line lighting system, four cable glands integrated on the top in size M25 without connection cables integrated in a mounting rail, length: 280 mm, material: aluminium, finish: aluminum bare without through-wiring with through-wiring	066503 066504	4260745237611 4260745237628
	supply cable, 7-pole, suitable for all feed systems 7-pole connection cable, ready-for-use, for tempLED RayLine line lighting systems, cable version: oilflex CL110 7G2.5, outer diameter: 11.1 mm, cable colour: grey, required quantities: 1x each for the start and end feeds and 2x each for the center feeds length: 1.00 meter length: 3.00 meters length: 5.00 meters	699038 699039 699040	4260745233088 4260745233095 4260745233101
	connection cable set as a kit, 2 x 7-pole connection cable set for self-assembly between two linear luminaire systems for self-assembly, for example for bridging roof beams of roof girders, ventilation shafts, cable stays or similar on-site installations, cable version: oilflex CL110 7G2.5, outer diameter: 11.1 mm, cable colour: grey, delivery includes one start- and one end feed for self-assembly length: 1.00 meter length: 3.00 meters length: 5.00 meters	066516 066517 066518	4260745237710 4260745237727 4260745237734

tempLED	Accessory catalogue RayLine Max V3	art.-no.	GTIN / EAN
	<p>universal adapter for mounting e.g. hall lights on the RayLine Max V3 line lighting system, maximum load capacity: 25 kg, material: steel, finish: hot-dip galvanized</p>	066514	4260745237697
	<p>small universal adapter for mounting e.g. information signs and traffic mirrors on the RayLine Max V3 line lighting system, maximum load capacity: 3 kg, material: steel, finish: hot-dip galvanized</p>	066515	4260745237703
	<p>universal power output, 5-pole universal power supply output for the RayLine Max V3 line lighting system, 5-pole socket, maximum load capacity: 230 VAC / 50-60 Hz - 10 A integrated in a mounting rail, length: 140 mm, material: aluminium, finish: aluminum bare with pin assignment 1 / 2 / 5 / 6 with pin assignment 1 / 2 / 3 / 4 with pin assignment 3 / 4 / 5 / 6</p>	066505 066506 066507	4260745237635 4260745237642 4260745237659
	<p>integrated universal power output, 5-pole technical data similar to the universal power output, but for fully integrated installation in a free blind module of the tempLED RayLine Max V3 line lighting system with pin assignment 1 / 2 / 5 / 6 with pin assignment 1 / 2 / 3 / 4 with pin assignment 3 / 4 / 5 / 6</p>	065544 065545 065546	4260745237765 4260745237833 4260745237840
	<p>motion- and photoelectric SensorSystem tempLED RayControl combined motion detector and photoelectric sensor system for the tempLED RayLine Max V3 line lighting system with integrated DALI/DALI-2 dimming, power supply and data exchange via the DALI control cables, maximum cable length: 300 meters, can be used at ambient temperatures from -20 to +45 degrees Celsius</p>		
	<p>SensorSystem MASTER motion detector with passive infrared (PIR) technology, detection range: 360 degrees, detection angle: 20 degrees, maximum mounting height: 17 meters, detection area: maximum 18 x 18 meters (at 17 meter mounting height), photoelectric sensor with measuring range from 2 to 2,000 lux, combined with a SensorSystem ControlBox to supply power to the sensors and evaluate the sensor signals, control and parameterisation via Bluetooth 4.0 and manufacturer's apps for Android and iOS, Bluetooth range: max. 15 meters, maximum controllable number of DALI light modules: 32, maximum additional number of sensors that can be evaluated and supplied: 3, integrated real-time clock (RTC) with 72-hour power blackout backup integrated in a mounting rail, length: 280 mm, material: aluminium, finish: aluminum bare</p>	066508	4260745237772
	<p>SensorSystem SLAVE motion detector with passive infrared (PIR) technology, detection range: 360 degrees, detection angle: 20 degrees, maximum mounting height: 17 meters, detection area: maximum 18 x 18 meters (at 17 meter mounting height), photoelectric sensor with measuring range from 2 to 2,000 lux, power supply and evaluation either via the SensorSystem ControlBox or the SensorSystem MASTER via the DALI control lines integrated in a mounting rail, length: 140 mm, material: aluminium, finish: aluminum bare</p>	066509	4260745237796
	<p>integrated SensorSystem MASTER technical data similar to SensorSystem MASTER, but for fully integrated installation in a free blind module of the tempLED RayLine Max V3 line lighting system</p>	065542	4260745237802
	<p>integrated SensorSystem SLAVE technical data similar to SensorSystem SLAVE, but for fully integrated installation in a free blind module of the tempLED RayLine Max V3 line lighting system</p>	065543	4260745237758
	<p>important notice: the tempLED RayControl (integrated) SensorSystem SLAVE can only be operated in conjunction with a(n) (integrated) SensorSystem MASTER or an external DALI/DALI-2 network with an appropriate power supply (10 to 22.5 VDC, 6 mA each).</p>		
	<p>emergency power module for centralized battery systems operation module without monitoring and addressing for centralized battery systems, controlling via centralized monitoring system, maximum switching capacity: 500 watts, can only be used at ambient temperatures of max. +50 degrees Celsius, mounted in the luminaire ready for use</p>	699015	4260669198999

tempLED	Accessory catalogue RayLine Max V3	art.-no.	GTIN / EAN
	Casambi control unit type 10 for integrating and controlling the RayLine Max V3 line lighting system via the Casambi network: suitable for all RayLine Max V3 line lights with integrated DALI/DALI-2 dimming, maximum controllable, number of DALI light modules: 10, can only be used at ambient temperatures of max. +50 degrees Celsius integrated in a mounting rail, length: 280 mm, material: aluminium, finish: aluminum bare	066511	4260745237666
	Casambi control unit type 60 for integrating and controlling the RayLine Max V3 line lighting system via the Casambi network: suitable for all RayLine Max V3 line lights with integrated DALI/DALI-2 dimming, maximum controllable, number of DALI light modules: 60, can only be used at ambient temperatures of max. +50 degrees Celsius integrated in a mounting rail, length: 280 mm, material: aluminium, finish: aluminum bare	066512	4260745237673
	ENLIGHTED control unit for controlling the tempLED RayLine Max V3 line lighting system via the ENLIGHTED network; suitable for all tempLED RayLine Max V3 line lights with integrated DALI/DALI-2 dimming, integrated motion detector with passive infrared (PIR) technology, detection angle: 360 degrees, maximum mounting height: 12 meters, detection area: maximum 28 x 28 meters (at 12 meter mounting height), integrated daylight sensor, maximum controllable number of luminaire mounting rails: 1 (optionally with 1.68, 3.36 or 5.04 meters), Bluetooth 4.0 - wireless network for data exchange between sensor and gateway with 128-bit AES encryption and a maximum range of 46 meters in free field, can only be used at ambient temperatures of 0 to +50 degrees Celsius integrated in a mounting rail, length: 140 mm, material: aluminium, finish: blank Important note: On-site commissioning and programming by specialised personnel required.	777047	4260745238786

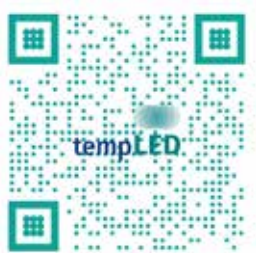
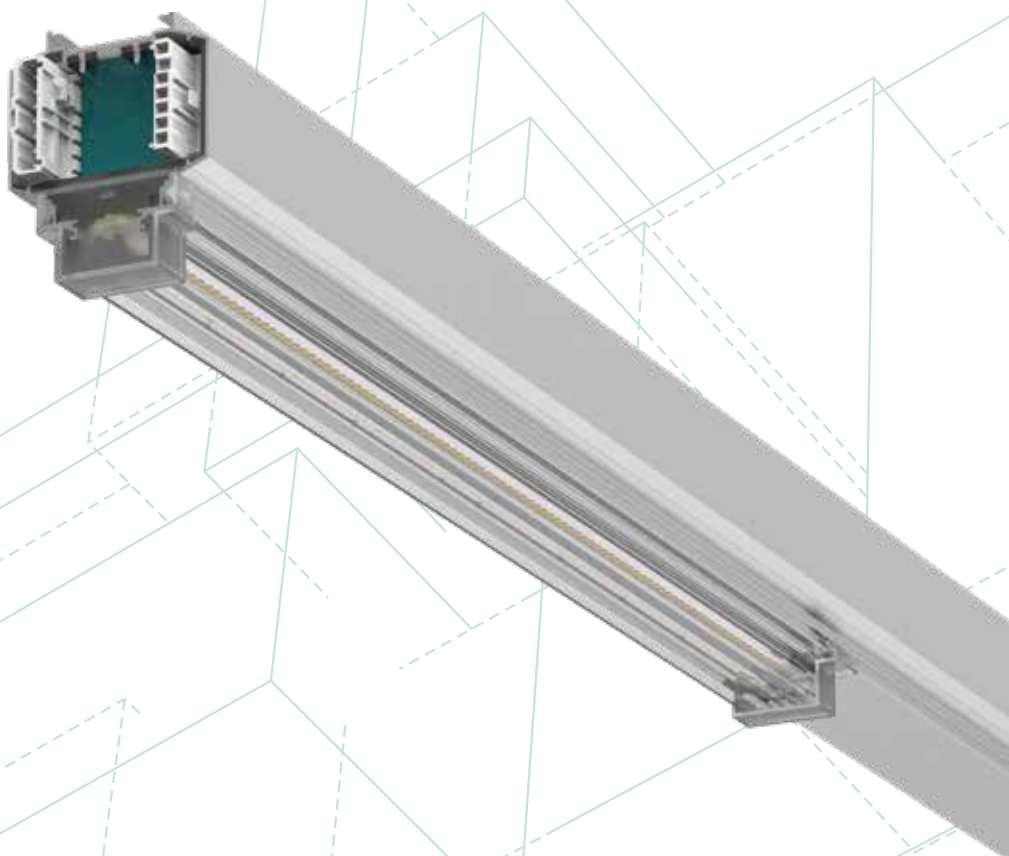

Direct link to the tempLED download portal

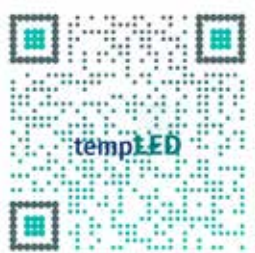

Direct link to the tempLED product configurator



LED is sustainable.
LED is the future.

tempLED luminaires fulfil a recycling rate of > 90%.
That is our product promise to you.

When will you start?