

www.tempLED.de

  
tempLED

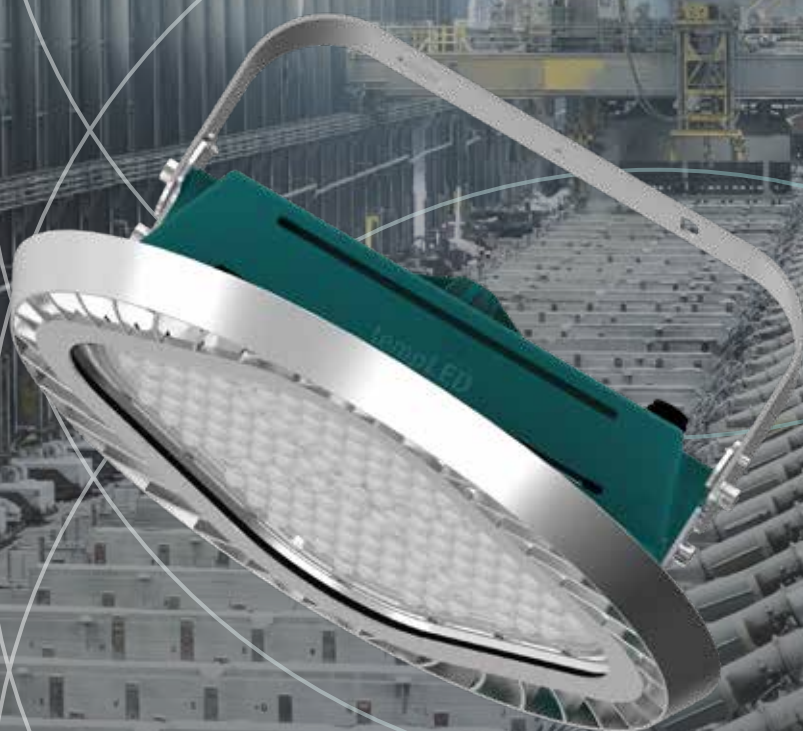

HIGH TEMPERATURE HALL LIGHT

# tempLED RayBeam Pro V2 HT

100 | 150 | 200 | 240

HALL LIGHTS 

HIGH TEMPERATURES 

Our customer  
Trimet

# tempLED

initial system efficiency  
170 lm / w



energy-efficient constant current  
power supply with integrated  
DALI-2 dimming and optional  
constant lumen output (CLO)



powerful, dust-permeable  
heat sink made of  
die-cast aluminum



impact and UV-resistant high-  
performance optical system  
with three practical beam angles



optional control  
and safety systems:



modular overall structure  
with exchangeable and repla-  
ceable main components



pressure compensation mem-  
brane to prevent condensation



solid luminaire housing opti-  
mized for high-temperature sur-  
roundings up to **+80° Celsius**

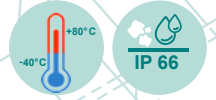

durable and bright  
LED light field

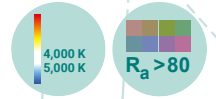

impact-resistant cover  
plate made of 5 mm  
toughened safety glass



## Light distribution curves tempLED RayBeam Pro V2 HT 100 | 150 | 200 | 240

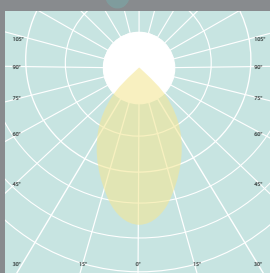

60 degrees symmetrical  
optical system

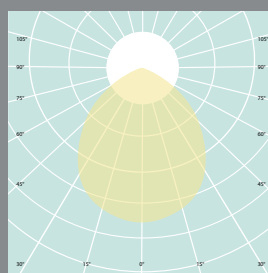

90 degrees symmetrical  
optical system

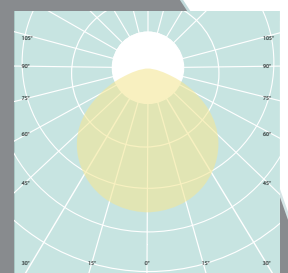

120 degrees symmetrical  
optical system



**tempLED RayBeam Pro V2 HT**  
100 | 150 | 200



**tempLED RayBeam Pro V2 HT**  
240



**Dimensions tempLED RayBeam Pro V2 HT**  
100 | 150 | 200 | 240

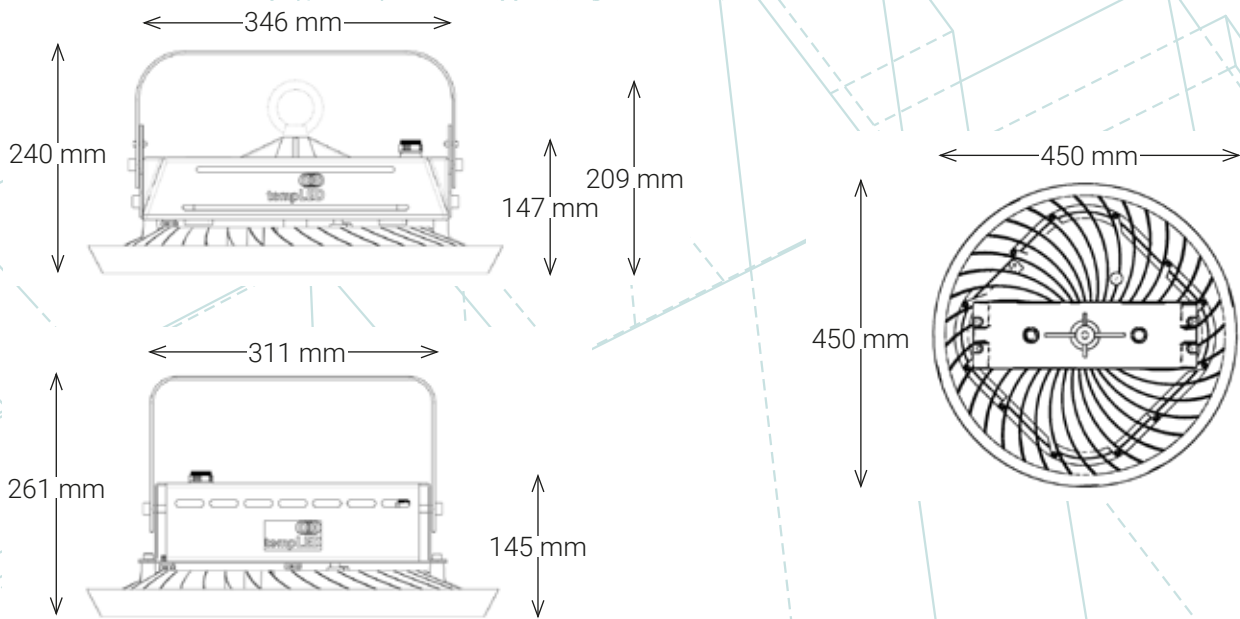

**Mounting options tempLED RayBeam Pro V2 HT**  
100 | 150 | 200 | 240

bracket mounting<sup>1,2</sup>



pendant mounting<sup>3</sup>



<sup>1</sup> Adjustment range for surface mounting with standard ceiling bracket: -45 to +45 degrees.

<sup>2</sup> Adjustment range for surface mounting with optional wall bracket (934039): 0 to 90 degrees.

<sup>3</sup> only for tempLED RayBeam Pro V2 100, 150 and 200 HT.

## General technical data

according to IEC, identical for all types of luminaires



### Lighting properties:

initial luminous flux:	17,000 to 40,800 lumens
luminous flux tolerance:	± 10 percent
initial system efficiency:	170 lumens / watt
initial, most similar color temperature:	4,000 kelvins   5,000 kelvins <sup>1</sup>
initial color rendering index (CRI):	Ra > 80
initial color consistency:	< 5 SDCM
available symmetrical beam angles:	60   90   120 degrees
photobiological safety:	IEC/TR 62778: 1
compact flicker degree (CFD):	1 percent

### Electrotechnical properties:

power supply AC:	90 to 240 volts <sup>2</sup>
supply frequency:	50 / 60 hertz
power supply DC:	127 to 250 volts <sup>3</sup>
system performance:	100 to 240 watts
system performance tolerance:	± 10 percent
power factor:	> 0.93
overvoltage protection:	yes
overheating protection:	yes
temperature monitoring:	yes
total harmonic distortion (THD):	< 20 percent
temperature classification (ATEX):	T5
Tc - temperature:	+89 degrees Celsius

### Energy characteristics:

Valid for all tempLED RayBeam Pro V2 HT: This product contains a light source of energy efficiency class B.

### Mounting options:

standard mounting options:	ceiling bracket with adjustment range -45 to +45 degrees pendant mounting with mounting eyelet (100 / 150 / 200 watts only)
optional mounting options:	wall bracket with adjustment range 0 to 90 degrees (934039)

<sup>1</sup> additional color temperatures on request.

<sup>2</sup> power supply 277 to 480 VAC, 50/60 Hz on request.

<sup>3</sup> power supply 352 to 500 VDC on request.

**Control and safety properties:**

dimming:	DALI-2
minimum dimming level:	10 percent
constant lumen output (CLO):	optional
control via the Casambi network:	optional <sup>1</sup>
emergency light module:	optional <sup>2</sup>
human centric lighting:	on request
daylight control system:	optional via the Casambi network <sup>1</sup>

**Housing properties:**

ambient temperature:	-40 to +80 degrees Celsius
ingress protection:	IP 66
impact resistance level:	IK08
electrical protection class:	I
limited surface temperatur (D):	yes
pressure compensation membrane:	yes
housing and heat sink material(s):	die-cast aluminum
material(s) and finish of the standard ceiling bracket:	stainless steel, powder-coated in white aluminium according to RAL 9006 <sup>3</sup>
material of optical system:	impact- and UV-resistant polycarbonate
cover plate material:	5 mm impact-resistant toughened safety glass, clear
luminaire housing color:	white aluminium according to RAL 9006 <sup>3</sup>
power supply housing color:	water blue according to RAL 5021 <sup>3</sup>
surface finish:	powder coating <sup>3</sup>
supply cable type:	H05SS-F 5G1
supply cable length:	250 centimeters
supply cable inlet:	plug connector
supply cable connection type:	open cable end
number of poles:	3 grid / 2 DALI

**Additional information:**

certificates:	ENEC in preparation
conformities:	CE and RoHS
lifespan (L70B10C1) @ Ta 25 degrees Celsius:	approx. 100,000 hours
lifespan (L70B10C1) @ Ta 80 degrees Celsius:	approx. 80,000 hours
lifespan (L90B10C1) @ Ta 25 degrees Celsius:	approx. 50,000 hours
guarantee:	5 years <sup>4</sup>
spare part guarantee:	10 years
delievery includes:	luminaire, ceiling bracket, fall protection and mounting eyelet if applicable

<sup>1</sup> can only be used at ambient temperatures of max. +50 degrees Celsius.

<sup>2</sup> can only be used at ambient temperatures from +5 to +50 degrees Celsius.

<sup>3</sup> optional luminaire housing colors and finishes: Paintings according to RAL colour chart, powder coatings according to RAL colour chart or synthetic resin coating.

<sup>4</sup> according to the warranty conditions of tempLED GmbH, excluding accessories.

**Logistic information:**

luminaire:	RayBeam Pro V2 100   150   200   240 HT
number of luminaires per package:	1
number of luminaires per pallet:	28
net weight of the luminaire:	9,500 g
gross weight per package:	11,500 g
package dimensions L x W x H:	510 x 510 x 270 mm

## tempLED 100

	RayBeam Pro V2 100 - 60 HT	RayBeam Pro V2 100 - 90 HT	RayBeam Pro V2 100 - 120 HT
article number:	342164	342194	342124
GTIN / EAN:	4260745239486	4260745239509	4260745239462
initial luminous flux:	17,000 lm	17,000 lm	17,000 lm
initial system efficiency:	170 lm/w	170 lm/w	170 lm/w
initial, most similar color temperature:	4,000 K	4,000 K	4,000 K
light distribution:	symmetrical	symmetrical	symmetrical
beam angle:	60 degrees	90 degrees	120 degrees
dimming / control:	DALI-2	DALI-2	DALI-2
system performance:	100 W	100 W	100 W
power consumption:	0.45 A	0.45 A	0.45 A
maximum inrush current:	24 A	24 A	24 A
dimensions (Ø x H):	450 x 240 mm	450 x 240 mm	450 x 240 mm

## tempLED 100

	RayBeam Pro V2 100 - 60 HT	RayBeam Pro V2 100 - 90 HT	RayBeam Pro V2 100 - 120 HT
article number:	342165	342195	342125
GTIN / EAN:	4260745239493	4260745239516	4260745239479
initial luminous flux:	17,000 lm	17,000 lm	17,000 lm
initial system efficiency:	170 lm/w	170 lm/w	170 lm/w
initial, most similar color temperature:	5,000 K	5,000 K	5,000 K
light distribution:	symmetrical	symmetrical	symmetrical
beam angle:	60 degrees	90 degrees	120 degrees
dimming / control:	DALI-2	DALI-2	DALI-2
system performance:	100 W	100 W	100 W
power consumption:	0.45 A	0.45 A	0.45 A
maximum inrush current:	24 A	24 A	24 A
dimensions (Ø x H):	450 x 240 mm	450 x 240 mm	450 x 240 mm

## tempLED 150

	RayBeam Pro V2 150 - 60 HT	RayBeam Pro V2 150 - 90 HT	RayBeam Pro V2 150 - 120 HT
article number:	342264	342294	342224
GTIN / EAN:	4260745239547	4260745239561	4260745239523
initial luminous flux:	25,500 lm	25,500 lm	25,500 lm
initial system efficiency:	170 lm/w	170 lm/w	170 lm/w
initial, most similar color temperature:	4,000 K	4,000 K	4,000 K
light distribution:	symmetrical	symmetrical	symmetrical
beam angle:	60 degrees	90 degrees	120 degrees
dimming / control:	DALI-2	DALI-2	DALI-2
system performance:	150 W	150 W	150 W
power consumption:	0.70 A	0.70 A	0.70 A
maximum inrush current:	24 A	24 A	24 A
dimensions (Ø x H):	450 x 240 mm	450 x 240 mm	450 x 240 mm

## tempLED 150

	RayBeam Pro V2 150 - 60 HT	RayBeam Pro V2 150 - 90 HT	RayBeam Pro V2 150 - 120 HT
article number:	342265	342295	342225
GTIN / EAN:	4260745239554	4260745239578	4260745239530
initial luminous flux:	25,500 lm	25,500 lm	25,500 lm
initial system efficiency:	170 lm/w	170 lm/w	170 lm/w
initial, most similar color temperature:	5,000 K	5,000 K	5,000 K
light distribution:	symmetrical	symmetrical	symmetrical
beam angle:	60 degrees	90 degrees	120 degrees
dimming / control:	DALI-2	DALI-2	DALI-2
system performance:	150 W	150 W	150 W
power consumption:	0.70 A	0.70 A	0.70 A
maximum inrush current:	24 A	24 A	24 A
dimensions (Ø x H):	450 x 240 mm	450 x 240 mm	450 x 240 mm

## tempLED 200

	RayBeam Pro V2 200 - 60 HT	RayBeam Pro V2 200 - 90 HT	RayBeam Pro V2 200 - 120 HT
article number:	342364	342394	342324
GTIN / EAN:	4260745239608	4260745239622	4260745239585
initial luminous flux:	34,000 lm	34,000 lm	34,000 lm
initial system efficiency:	170 lm/w	170 lm/w	170 lm/w
initial, most similar color temperature:	4,000 K	4,000 K	4,000 K
light distribution:	symmetrical	symmetrical	symmetrical
beam angle:	60 degrees	90 degrees	120 degrees
dimming / control:	DALI-2	DALI-2	DALI-2
system performance:	200 W	200 W	200 W
power consumption:	0.90 A	0.90 A	0.90 A
maximum inrush current:	24 A	24 A	24 A
dimensions (Ø x H):	450 x 240 mm	450 x 240 mm	450 x 240 mm

STOCK  
ITEM

## tempLED 200

	RayBeam Pro V2 200 - 60 HT	RayBeam Pro V2 200 - 90 HT	RayBeam Pro V2 200 - 120 HT
article number:	342365	342395	342325
GTIN / EAN:	4260745239615	4260745239639	4260745239592
initial luminous flux:	34,000 lm	34,000 lm	34,000 lm
initial system efficiency:	170 lm/w	170 lm/w	170 lm/w
initial, most similar color temperature:	5,000 K	5,000 K	5,000 K
light distribution:	symmetrical	symmetrical	symmetrical
beam angle:	60 degrees	90 degrees	120 degrees
dimming / control:	DALI-2	DALI-2	DALI-2
system performance:	200 W	200 W	200 W
power consumption:	0.90 A	0.90 A	0.90 A
maximum inrush current:	24 A	24 A	24 A
dimensions (Ø x H):	450 x 240 mm	450 x 240 mm	450 x 240 mm

STOCK  
ITEMSTOCK  
ITEMSTOCK  
ITEM

tempLED **240**









	RayBeam Pro V2 240 - 60 HT	RayBeam Pro V2 240 - 90 HT	RayBeam Pro V2 240 - 120 HT
article number:	342464	342494	342424
GTIN / EAN:	4260745239660	4260745239684	4260745239646
initial luminous flux:	40,800 lm	40,800 lm	40,800 lm
initial system efficiency:	170 lm/w	170 lm/w	170 lm/w
initial, most similar color temperature:	4,000 K	4,000 K	4,000 K
light distribution:	symmetrical	symmetrical	symmetrical
beam angle:	60 degrees	90 degrees	120 degrees
dimming / control:	DALI-2	DALI-2	DALI-2
system performance:	240 W	240 W	240 W
power consumption:	1.04 A	1.04 A	1.04 A
maximum inrush current:	24 A	24 A	24 A
dimensions (Ø x H):	450 x 261 mm	450 x 261 mm	450 x 261 mm

tempLED **240**

	RayBeam Pro V2 240 - 60 HT	RayBeam Pro V2 240 - 90 HT	RayBeam Pro V2 240 - 120 HT
article number:	342465	342495	342425
GTIN / EAN:	4260745239677	4260745239691	4260745239653
initial luminous flux:	40,800 lm	40,800 lm	40,800 lm
initial system efficiency:	170 lm/w	170 lm/w	170 lm/w
initial, most similar color temperature:	5,000 K	5,000 K	5,000 K
light distribution:	symmetrical	symmetrical	symmetrical
beam angle:	60 degrees	90 degrees	120 degrees
dimming / control:	DALI-2	DALI-2	DALI-2
system performance:	240 W	240 W	240 W
power consumption:	1.04 A	1.04 A	1.04 A
maximum inrush current:	24 A	24 A	24 A
dimensions (Ø x H):	450 x 261 mm	450 x 261 mm	450 x 261 mm

STOCK  
ITEMSTOCK  
ITEM



tempLED	Accessory catalogue RayBeam Pro V2 HT	art.-no.	GTIN / EAN
	<b>wall bracket</b> surface bracket for wall mounting, adjustment range of the luminaire: 0 to 90 degrees, material: stainless steel, finish: natural <b>suitable for tempLED RayBeam Pro V2 100, 150 and 200 HT</b> <b>suitable for tempLED RayBeam Pro V2 240 HT</b>	934039 934258	4260669194311 4260745238823
	<b>locking device for ball impact safety</b> adjustable and lockable mounting bracket with scale for ball impact safety, material: steel, finish: powder coating in white aluminium according to RAL 9006, delivery as a set of 2	935540	4260491842350
	<b>safety plug</b> 3-pin safety plug with ingress protection IP 44, installed on the supply cable of the luminaire	945400	4260491842251
	<b>supply cable extension</b> ready-to-use 5-pin supply cable extension up to 10 meters	933566	4260745235570
	<b>Wieland connector RST 20i5</b> 5-pin socket part; color coding: turquoise blue, 250 V, 20 A, with protective conductor, for cable diameter 6 - 10 mm	945430	4260491842329
	<b>Wieland connector RST 20i5</b> 5-pin connector part; color coding: turquoise blue, 250 V, 20 A, with protective conductor, installed on the supply cable of the luminaire	945431	4260491842336
	<b>cover plate polycarbonate</b> impact-resistant cover plate, thickness 5 mm, material: polycarbonat, finish: clear	333902	42604919843753
	<b>Casambi control unit</b> for integrating and controlling the luminaire via the Casambi network, can only be used at ambient temperatures of max. +50 degrees Celsius, mounted on the luminaire ready for use	934187	4260669198203
	<b>emergency light module</b> with automatic detection of failure and return of supply voltage, display of functional status, battery type: LiFePO4, running time approx. 3 hours with an output power of approx. 3,5 watts, recharging time: approx. 24 hours, can only be used at ambient temperatures from +5 to +50 degrees Celsius, mounted on the luminaire ready for use <b>suitable for tempLED RayBeam Pro V2 100, 150 and 200 HT</b> <b>suitable for tempLED RayBeam Pro V2 240 HT</b>	341900 341900	4260745237246 4260745237253



Direct link to the tempLED  
download portal



LED is sustainable.  
LED is the future.

tempLED luminaires fulfil a recycling rate of > 90%.  
That is our product promise to you.

When will you start?